

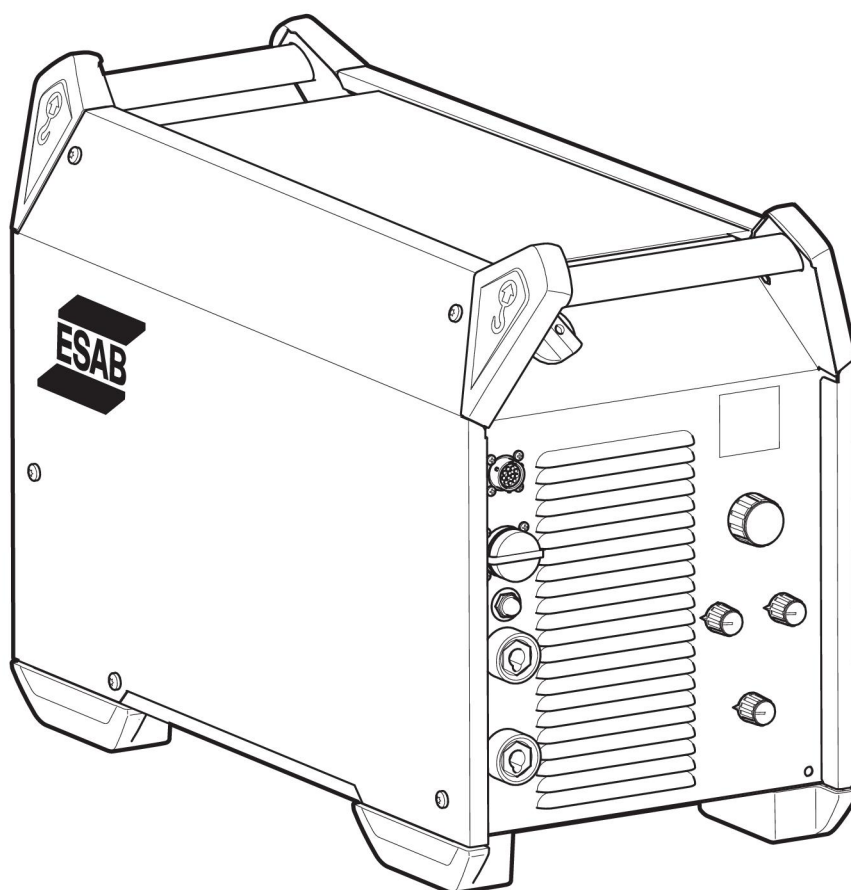

Warrior™ 400i CC/CV

Warrior™ 500i CC/CV



Instruction manual



DECLARATION OF CONFORMITY

According to

The Low Voltage Directive 2006/95/EC, entering into force 16 January 2007

The EMC Directive 2004/108/EC, entering into force 20 July 2007

The RoHS Directive 2011/65/EC, entering onto force 2 January 2013

Type of equipment

Welding power source

Type designation

Warrior™ 400i CV/CC and Warrior™ 500i CV/CC, , from serial number 324 xxx xxxx (2013 w24)

Brand name or trade mark

ESAB

Manufacturer or his authorised representative established within the EEA

Name, address, telephone No:

ESAB AB
Lindholmsallén 9,
Box 8004,
SE-402 77 Göteborg,
Sweden

Phone: +46 31 50 90 00, Fax: +46 584 411 924

The following harmonised standard in force within the EEA has been used in the design:

EN 60974-1, Arc Welding Equipment – Part 1: Welding Power Sources

EN 60974-10, Arc Welding Equipment – Part 10: Electromagnetic Compatibility (EMC) requirements

Additional Information: Restrictive use, Class A equipment, intended for use in locations other than residential.

By signing this document, the undersigned declares as manufacturer, or the manufacturer's authorised representative established within the EEA, that the equipment in question complies with the safety requirements stated above.

Date

Gothenburg
14-June-2013

Signature

A handwritten signature in black ink, appearing to read 'Stephen Argo'. The signature is written in a cursive, flowing style.

Stephen Argo

Clarification

Position

Global Director
Equipment

TABLE OF CONTENTS

1	SAFETY	4
2	INTRODUCTION	7
	2.1 Overview	7
	2.2 Equipment.....	7
3	TECHNICAL DATA	8
4	INSTALLATION	10
	4.1 General.....	10
	4.2 Lifting instructions.....	10
	4.3 Location	10
	4.4 Mains supply	11
5	OPERATION	14
	5.1 Overview	14
	5.2 Connections and control devices.....	14
	5.3 Connection of welding and return cables.....	15
	5.4 Turning the mains power on/off.....	15
	5.5 Fan control.....	15
	5.6 Symbols and functions.....	15
6	MAINTENANCE	18
	6.1 Overview	18
	6.2 Power source.....	18
	6.3 Welding torch	18
7	FAULT TRACING	19
8	ORDERING SPARE PARTS	20
	DIAGRAM	21
	ORDERING NUMBERS	22
	ACCESSORIES	23

Rights reserved to alter specifications without notice.

1 SAFETY

Users of ESAB equipment have the ultimate responsibility for ensuring that anyone who works on or near the equipment observes all the relevant safety precautions. Safety precautions must meet the requirements that apply to this type of equipment. The following recommendations should be observed in addition to the standard regulations that apply to the workplace.

All work must be carried out by trained personnel well-acquainted with the operation of the equipment. Incorrect operation of the equipment may lead to hazardous situations which can result in injury to the operator and damage to the equipment.

1. Anyone who uses the equipment must be familiar with:
 - its operation
 - location of emergency stops
 - its function
 - relevant safety precautions
 - welding and cutting or other applicable operation of the equipment
2. The operator must ensure that:
 - no unauthorised person is stationed within the working area of the equipment when it is started up
 - no-one is unprotected when the arc is struck or work is started with the equipment
3. The workplace must:
 - be suitable for the purpose
 - be free from drafts
4. Personal safety equipment:
 - Always wear recommended personal safety equipment, such as safety glasses, flame-proof clothing, safety gloves
 - Do not wear loose-fitting items, such as scarves, bracelets, rings, etc., which could become trapped or cause burns
5. General precautions:
 - Make sure the return cable is connected securely
 - Work on high voltage equipment **may only be carried out by a qualified electrician**
 - Appropriate fire extinguishing equipment must be clearly marked and close at hand
 - Lubrication and maintenance must **not** be carried out on the equipment during operation

**WARNING!**

Arc welding and cutting can be injurious to yourself and others. Take precautions when welding and cutting. Ask for your employer's safety practices which should be based on manufacturers' hazard data.

ELECTRIC SHOCK - Can kill

- Install and earth the unit in accordance with applicable standards
- Do not touch live electrical parts or electrodes with bare skin, wet gloves or wet clothing
- Insulate yourself from earth and the workpiece
- Ensure your working stance is safe

FUMES AND GASES - Can be dangerous to health

- Keep your head out of the fumes
- Use ventilation, extraction at the arc, or both, to take fumes and gases away from your breathing zone and the general area

ARC RAYS - Can injure eyes and burn skin

- Protect your eyes and body. Use the correct welding screen and filter lens and wear protective clothing
- Protect bystanders with suitable screens or curtains

FIRE HAZARD

- Sparks (spatter) can cause fire. Make sure therefore that there are no inflammable materials nearby

NOISE - Excessive noise can damage hearing

- Protect your ears. Use earmuffs or other hearing protection. Protect your ears. Use earmuffs or other hearing protection
- Warn bystanders of the risk

MALFUNCTION - Call for expert assistance in the event of malfunction.

Read and understand the instruction manual before installing or operating.

PROTECT YOURSELF AND OTHERS!

**WARNING!**

Do not use the power source for thawing frozen pipes.

**CAUTION!**

Read and understand the instruction manual before installing or operating.

**CAUTION!**

This product is solely intended for arc welding.



CAUTION!

Class A equipment is not intended for use in residential locations where the electrical power is provided by the public low-voltage supply system. There may be potential difficulties in ensuring electromagnetic compatibility of class A equipment in those locations, due to conducted as well as radiated disturbances.

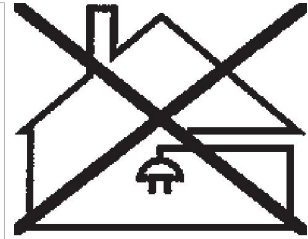

NOTE!

Dispose of electronic equipment at the recycling facility!

In observance of European Directive 2002/96/EC on Waste Electrical and Electronic Equipment and its implementation in accordance with national law, electrical and/or electronic equipment that has reached the end of its life must be disposed of at a recycling facility.

As the person responsible for the equipment, it is your responsibility to obtain information on approved collection stations.

For further information contact the nearest ESAB dealer.



ESAB can provide you with all necessary welding protection and accessories.

2 INTRODUCTION

2.1 Overview

The **Warrior 400i CC/CV** and **Warrior 500i CC/CV** are welding power sources intended for MIG/MAG welding, as well as for welding with powder filled cored wire (FCAW-S), for TIG welding, for welding with coated electrodes (MMA) and for arc air gouging.

The power sources are intended for use with the following wire feed units:

- Warrior Feed 304
- Warrior Feed 304w

ESAB's accessories for the product can be found in the "ACCESSORIES" chapter of this manual.

2.2 Equipment

The power source is supplied with:

- 5 m return cable with earth clamp
- 3 m mains cable
- instruction manual

3 TECHNICAL DATA

	Warrior 400i CC/CV	Warrior 500i CC/CV
Mains voltage	380-415 V \pm 10%, 3~ 50/60 Hz	380-415 V \pm 10%, 3~ 50/60 Hz
Mains supply S_{scmin}	6.4 MVA	7.2 MVA
Mains supply Z_{max}	0.025 Ω	0.022 Ω
Primary current I_{max}		
MIG/MAG	28 A	37 A
TIG	23 A	30 A
MMA	28 A	38 A
No-load power in energy-saving mode 6.5 min. after welding	30 W	30 W
Setting range		
MIG/MAG	16 A/15 V - 400 A/34 V	16 A/15 V - 500 A/39 V
TIG	5 A/10 V - 400 A/26 V	5 A/10 V - 500 A/30 V
MMA	16 A/20 V - 400 A/36 V	16 A/20 V - 500 A/40 V
Permissible load at MIG/MAG		
60 % duty cycle	400 A/34 V	500 A/39 V
100% duty cycle	300 A/29 V	400 A/34 V
Permissible load at TIG		
60 % duty cycle	400 A/26 V	500 A/30 V
100% duty cycle	300 A/22 V	400 A/26 V
Permissible load at MMA		
60 % duty cycle	400 A/36 V	500 A/40 V
100% duty cycle	300 A/32 V	400 A/36 V
Power factor at maximum current	0.91	0.91
Efficiency at maximum current	88 %	89 %
Electrode types	Basic Rutile Cellulosic	Basic Rutile Cellulosic
Open-circuit voltage		
VRD 35 V deactivated	56 V DC peak	56 V DC peak
VRD 35 V activated	28 V DC peak	28 V DC peak
Apparent power at maximum current	18.0 kVA	24.6 kVA
Active power at maximum current	16.4 kW	22.5 kW
Operating temperature	-10 to +40°C	-10 to +40°C
Transportation temperature	-20 to +55°C	-20 to +55°C
Constant sound pressure when idling	<70 db (A)	<70 db (A)

	Warrior 400i CC/CV	Warrior 500i CC/CV
Dimensions l × w × h	712 × 325 × 470 mm	712 × 325 × 470 mm
Weight	58.5 kg	58.5 kg
Insulation class	H	H
Enclosure class	IP 23	IP 23
Application class	S	S

Mains supply, $S_{sc\ min}$

Minimum short circuit power on the network in accordance with IEC 61000-3-12.

Mains supply, Z_{max}

Maximum permissible line impedance of the network in accordance with IEC 61000-3-11.

Duty cycle

The duty cycle refers to the time as a percentage of a ten-minute period that you can weld or cut at a certain load without overloading. The duty cycle is valid for 40°C.

Enclosure class

The **IP** code indicates the enclosure class, i. e. the degree of protection against penetration by solid objects or water.

Equipment marked **IP23** is intended for indoor and outdoor use.

Application class

The symbol **S** indicates that the power source is designed for use in areas with increased electrical hazard.

4 INSTALLATION

4.1 General

The installation must be carried out by a professional.

4.2 Lifting instructions

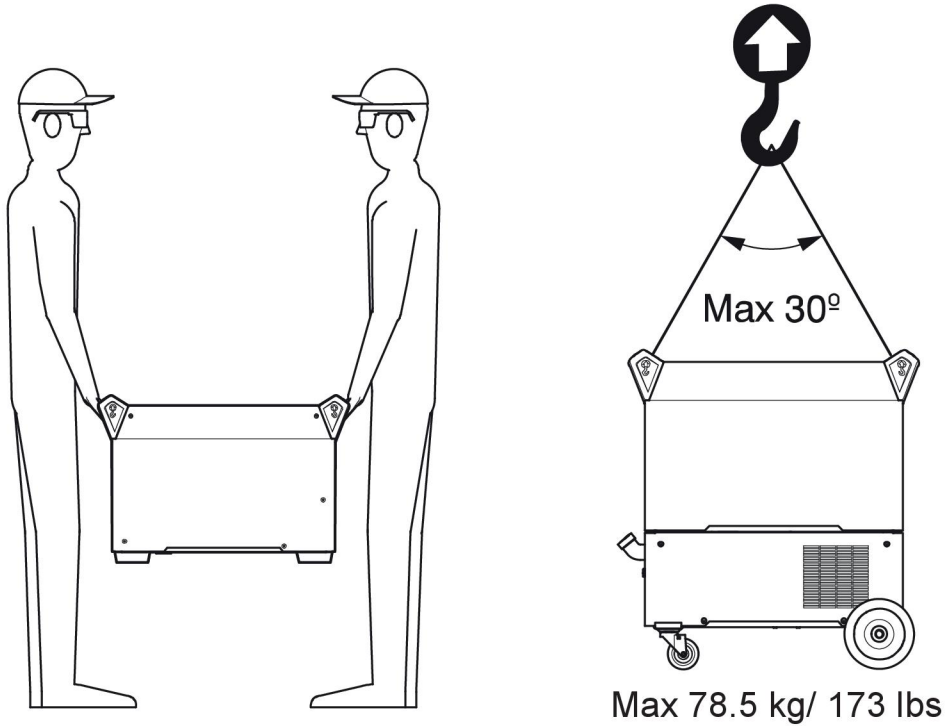

WARNING!

Secure the equipment - particularly if the ground is uneven or sloping.

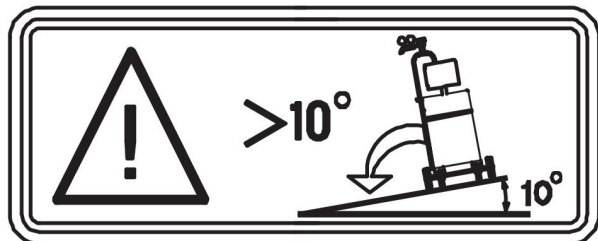

4.3 Location

Position the welding power source such that its cooling air inlets and outlets are not obstructed.

4.4 Mains supply



NOTE!

Mains supply requirements

This equipment complies with IEC 61000-3-12 provided that the short-circuit power is greater than or equal to S_{scmin} at the interface point between the user's supply and the public system. It is the responsibility of the installer or user of the equipment to ensure, by consultation with the distribution network operator if necessary, that the equipment is connected only to a supply with a short-circuit power greater than or equal to S_{scmin} . Refer to the technical data in the Technical data section.

Make sure that the welding power source is connected to the correct supply voltage and that it is protected by the correct fuse rating. A protective earth connection must be made in accordance with regulations.

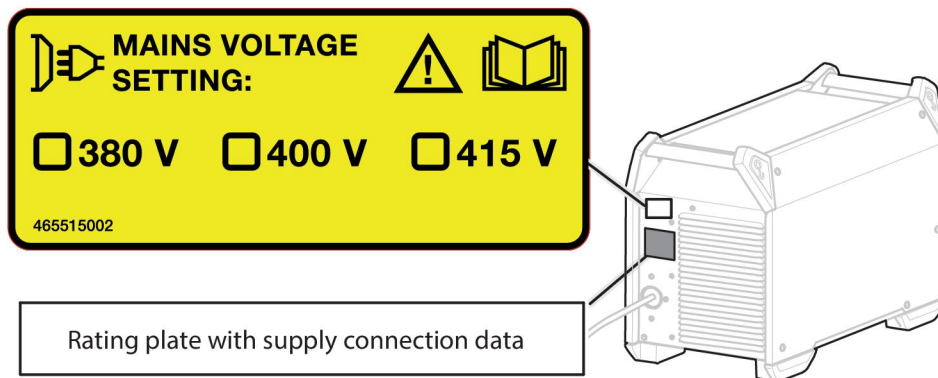

Table 1. Recommended fuse sizes and minimum cable area Warrior 400i CC/CV

Warrior 400i CC/CV			
Mains voltage	380 V 3~ 50/60 Hz	400 V 3~ 50/60 Hz	415 V 3~ 50/60 Hz
Mains cable area	4 × 6 mm ²	4 × 6 mm ²	4 × 6 mm ²
Maximal current rating I_{max}	28 A	27 A	25 A
I_{1eff}			
MIG/MAG	20 A	19 A	18 A
TIG	16 A	16 A	14 A
MMA	21 A	20 A	19 A
Fuse			
anti-surge	25 A	25 A	20 A
type C MCB	25 A	25 A	20 A

Table 2. Recommended fuse sizes and minimum cable area Warrior 500i CC/CV

Warrior 500i CC/CV			
Mains voltage	380 V 3~ 50/60 Hz	400 V 3~ 50/60 Hz	415 V 3~ 50/60 Hz
Mains cable area	4 × 6 mm ²	4 × 6 mm ²	4 × 6 mm ²
Maximal current rating I_{max}	38 A	36 A	35 A
I_{1eff}			
MIG/MAG	28 A	27 A	26 A
TIG	23 A	22 A	26 A
MMA	29 A	28 A	26 A
Fuse			
anti-surge	35 A	35 A	35 A
type C MCB	32 A	32 A	32 A

**NOTE!**

The mains cable areas and fuse sizes as shown above are in accordance with Swedish regulations. Use the power source in accordance with the relevant national regulations.

Connection instruction

The power source is factory set to 400 V AC. If another mains voltage setting is required, the cable on the printed circuit board has to be moved and put in the correct position. Also the label, at the rear of the power source, marked with the mains voltage setting must be updated. This operation must be done by a person who has the appropriate electrical knowledge.

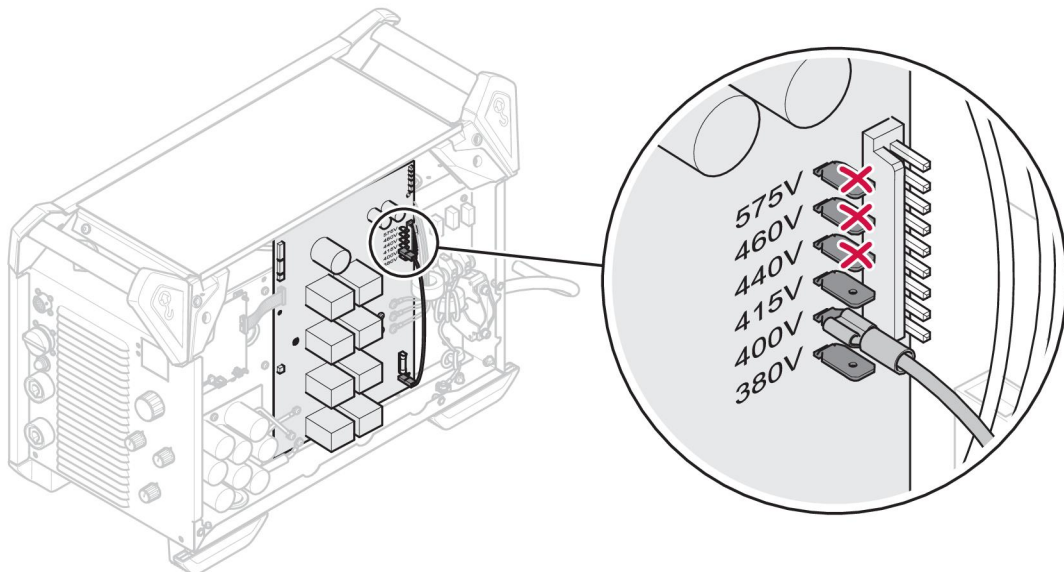
**NOTE!**

This power source version is designed for a nominal input voltage from 380 to 415 V AC. ESAB does not recommend a connection of the cable on the circuit board in the position of 440 , 460 or 575 V AC.

4 INSTALLATION

If the mains cable needs to be changed, the earth connection to the bottom plate and the ferrites must be installed correctly. See the picture below for the installation order of the ferrites, washers, nuts and screws.

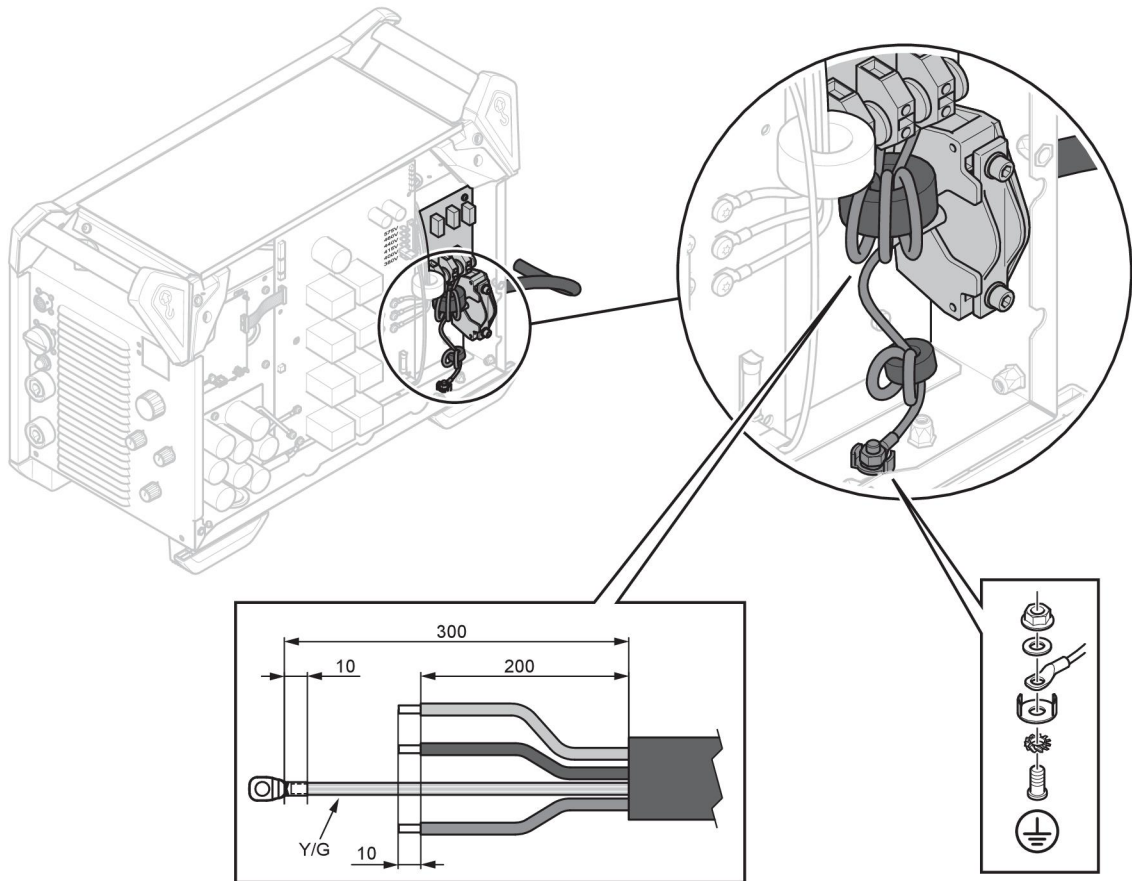

5 OPERATION

5.1 Overview

General safety regulations for handling the equipment can be found in the chapter "Safety". Read it through before you start the equipment.

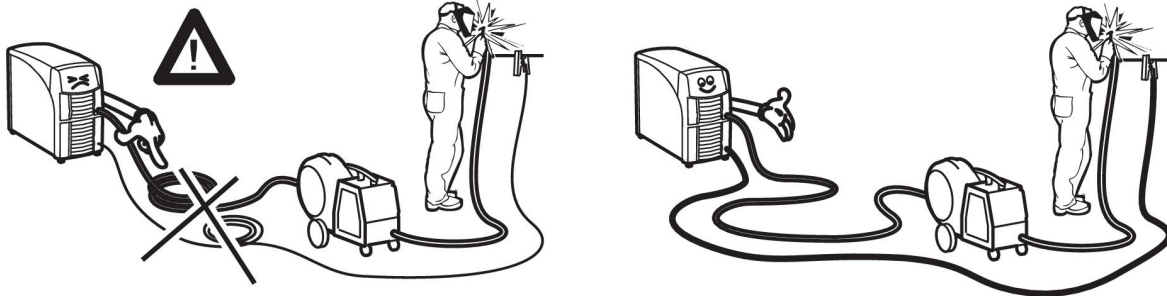

5.2 Connections and control devices

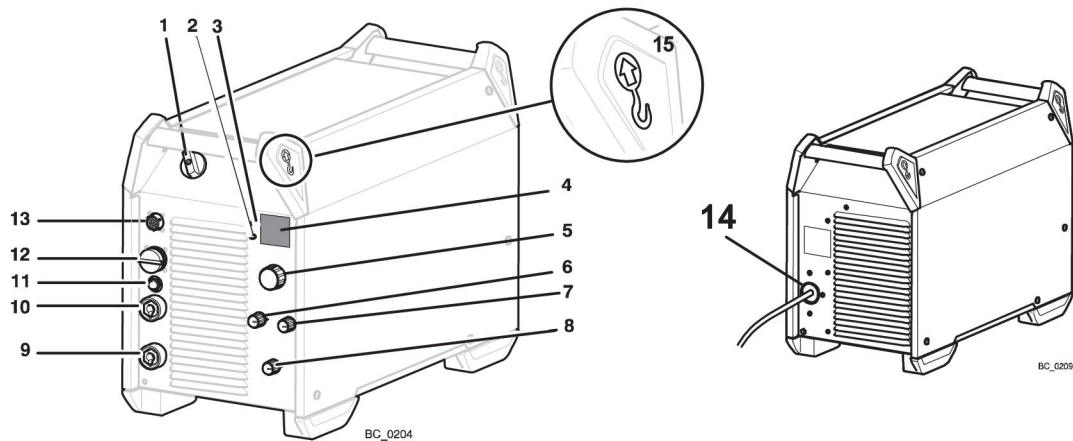

- | | |
|---|--|
| 1. Mains power supply switch, O/I | 9. Connection (-): MIG/MAG: Return cable
TiG: Welding torch MMA: Return cable or welding cable |
| 2. Indicator lamp, yellow, overheating | 10. Connection (+): MIG/MAG: Welding cable
TiG: Return cable MMA: Welding cable or return cable |
| 3. Indicator lamp, green, VRD function (reduced open-circuit voltage) | 11. Circuit breaker, 10 A, 42 V |
| 4. Display, current (A) and voltage (V) | 12. Connection of wire feed unit |
| 5. Knob for setting: MMA/TIG Arc air gouging: Current (A) Mobile Feed mode: Voltage (V) | 13. Connection of remote control unit (option) |
| 6. Knob for choice of electrode type | 14. Connection of mains power supply |
| 7. Knob for inductance (MIG/MAG) and arc force (MMA): | 15. Lifting eye bolt |
| 8. Knob for welding method | |

5.3 Connection of welding and return cables

The power source has two outputs, a positive terminal (+) and a negative terminal (-), for connecting welding and return cables. The output to which the welding cable is connected depends on the welding method or type of electrode used.

Connect the return cable to the other output on the power source. Secure the return cable's contact clamp to the work piece and ensure that there is good contact between the work piece and the output for the return cable on the power source.

For MMA welding, the welding cable can be connected to the positive terminal (+) or negative terminal (-) depending on the type of electrode used. The connecting polarity is stated on the electrode packaging.

5.4 Turning the mains power on/off

Turn on the mains power by turning switch to the "I" position, see 1 on the picture above.

Turn the unit off by turning the switch to the "O" position.

Whether the mains power supply is interrupted or the power source is switched off in the normal manner, welding data will be stored so that it is available next time the unit is started.









CAUTION!





Do not turn off the power source during welding (with load).

5.5 Fan control

The power source has a time control that means that the fans continue to run for 6.5 minutes after welding has stopped, and the power source switches to energy-saving mode. The fans start again when welding restarts.

5.6 Symbols and functions

	Placement of lifting eye	VRD	Voltage Reducing Device
	Overheating protection	Basic	Basic electrode
Rutile	Rutile electrode	Cel	Cellulosic electrode
	Arc force		Inductance
	TIG welding (Live TIG)		Arc air gouging

	MMA welding		MIG/MAG welding
 Mobile Feed CV	Wire feed unit Mobile feed CV (Constant voltage)		Protective earth

Voltage reducing device (VRD)

The VRD function ensures that the open-circuit voltage does not exceed 35 V when welding is not being carried out. This is indicated by a lit VRD led.

The VRD function is blocked when the system senses that welding has started.

Contact an authorised ESAB service technician to activate the function.

Overheating protection

The welding power source has overheating protection that operates if the temperature becomes too high. When this occurs the welding current is interrupted and an overheating indication lamp is lit.

The overheating protection resets automatically when the temperature has fallen, within normal working temperature.

Arc force

The arc force is important in determining how the current changes in response to a change in the arc length. A lower value gives a calmer arc with less spatter.

It only applies to MMA welding.

Inductance

Higher inductance results in a wider weld pool and less spatter. Lower inductance produces a harsher sound but a stable, concentrated arc.

It only applies to MIG/MAG welding.

TIG welding

TIG welding melts the metal of the workpiece, using an arc struck from a tungsten electrode, which does not itself melt. The weld pool and the electrode are protected by shielding gas.

"Live TIG-start"

At a "Live TIG-start" the tungsten electrode is placed against the workpiece. When the electrode is lifted away from workpiece, the arc is struck at a limited current level.

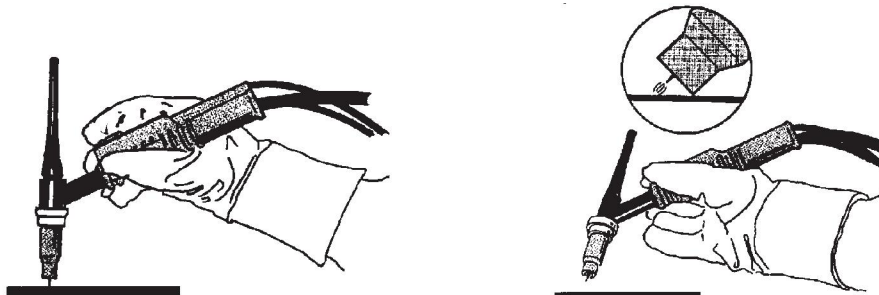

For TIG welding, the welding power source shall be supplemented with:

- a TIG torch with gas valve
- an argon gas cylinder

- an argon gas regulator
- tungsten electrode

Arc air gouging

With arc air gouging, a special electrode comprising a carbon rod with a copper casing is used.

An arc is formed between the carbon rod and the workpiece, which melts the material. Compressed air is supplied so that the melted material is blown away.

For arc air gouging the power source shall be supplemented with:

- arc air torches
- return cable with clamp
- air pressure

Table 3. Recommended for gouging

Electrode	Voltage min.	Voltage max.	Electrode Extension
6 mm (1/4")	36 V	49 V	50 - 76 mm (2 - 3")
8 mm (5/16")	39 V	52 V	
10 mm (3/8")	43 V	52 V	

MMA welding

MMA welding may also be referred to as welding with coated electrodes. Striking the arc melts the electrode, and its coating forms protective slag.

For MMA welding the power source shall be supplemented with:

- welding cable with electrode holder
- return cable with clamp

MIG/MAG and self shielded cored wire welding

An arc melts a continuously supplied wire. The weld pool is protected by shielding gas.

For MIG/MAG and self shielded core wire welding, the power source shall be supplemented with:

- wire feed unit
- welding torch
- connection cable between power source and wire feed unit
- gas cylinder
- return cable with clamp

6 MAINTENANCE

6.1 Overview

Regular maintenance is important for safe, reliable operation.

Only personnel with the appropriate electrical skills (authorized staff) may remove safety plates.



CAUTION!

All warranty undertakings from the supplier cease to apply if the customer attempts any work to rectify any faults in the product during the warranty period.

6.2 Power source

Check regularly that the welding power source is not clogged with dirt. Clogged or blocked air inlets and outlets can result in overheating.

How often and which cleaning methods apply depend on:

- the welding process
- the arc times
- the environment
- the surrounding environment

It is normally sufficient to blow down the power source with dry compressed air (reduced pressure) once a year.

6.3 Welding torch

A regular programme of care and maintenance reduces unnecessary and expensive downtime.

Each time a wire bobbin is changed, the welding torch should be removed from the power source and blown clean with compressed air.

The wire end must not have sharp edges when inserted into the wire liner.

For detailed information see instruction manuals for welding torches.

7 FAULT TRACING

Try these recommended checks and inspections before sending for an authorized service technician.

Type of fault	Corrective action
No arc.	<ul style="list-style-type: none"> • Check that the mains power supply switch is turned on. • Check that the mains, welding and return cables are correctly connected. • Check that the correct current value is set. • Check the mains power supply fuses.
The welding current is interrupted during welding.	<ul style="list-style-type: none"> • Check whether the overloading protection has deployed (indicated on the front). • Check the mains power supply fuses. • Check that the return cable is correctly fastened.
The overheating protection trips frequently.	<ul style="list-style-type: none"> • Make sure that you are not exceeding the rated data for the power source (i.e. that the unit is not being overloaded).
Poor welding performance.	<ul style="list-style-type: none"> • Check that the welding and return cables are correctly connected. • Check that the correct current value is set. • Check that the correct wire or electrode is used. • Check the mains power supply fuses. • Check the gas pressure in the equipment connected to the power source.
"Err" on display in open circuit mode	<ul style="list-style-type: none"> • Check the mains power supply fuses. • Check that the voltage on the voltage selection label on the rear of the power source is equal to the nominal mains voltage. • Restart the power source with the main switch

8 ORDERING SPARE PARTS

Repair and electrical work should be performed by an authorised ESAB service technician. Use only ESAB original spare and wear parts.

The Warrior 400i CC/CV and Warrior 500i CC/CV are designed and tested in accordance with international and european standards IEC/EN 60974-1 and IEC/EN 60974-10. On completion of service or repair work, it is the responsibility of the person(s) performing the work to ensure that the product still complies with the requirements of the above standard.

Spare parts may be ordered through your nearest ESAB dealer, see the last page of this document.

DIAGRAM

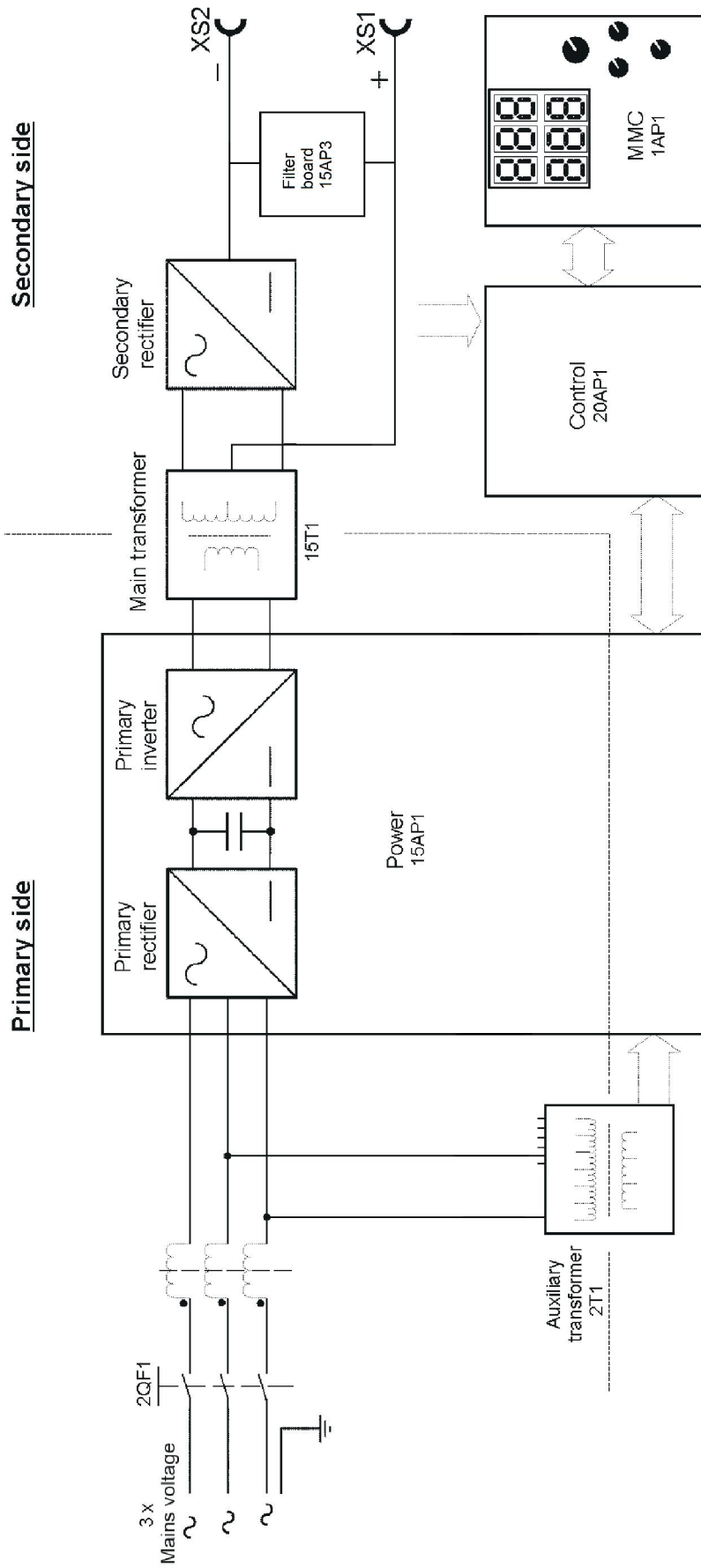



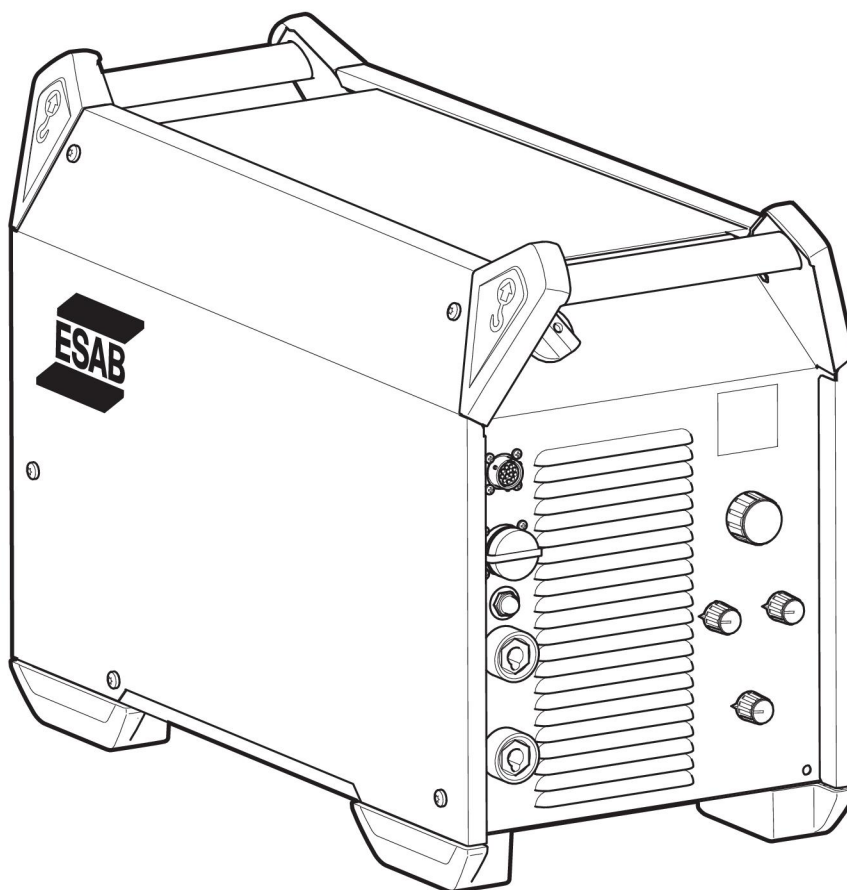

ORDERING NUMBERS

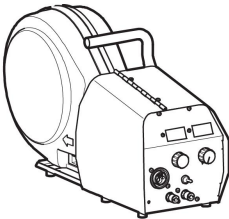
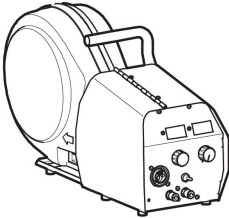

Ordering number	Denomination	Type	Notes
0465 350 884	Welding power source	Warrior 400i CC/CV	380-415 V
0465 350 883	Welding power source	Warrior 500i CC/CV	380-415 V
0464 254 001	Spare parts list		
0464 523 001	Service manual		

Technical documentation is available on the Internet at www.esab.com

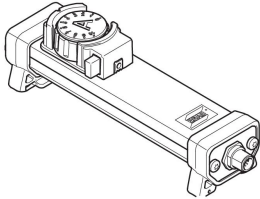
ACCESSORIES

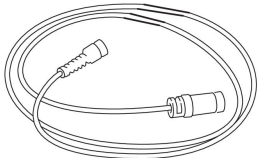
0465 250 880	Warrior™ Feed 304	
0465 250 881	Warrior™ Feed 304w, with water cooling	
0558 005 728	MobileFeed 300 AVS	
0459 491 896	Remote control unit AT1 MMA and TIG current	
0459 491 897	Remote control unit AT1 CF MMA and TIG: course and fine setting of current	
Remote control cable 12 pole - 8 pole		
0459 552 880	5 m	
0459 552 881	10 m	
0459 552 882	15 m	
0459 552 883	25 m	

ACCESSORIES

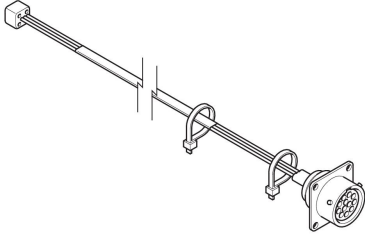
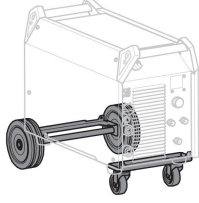
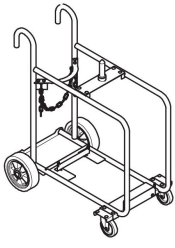
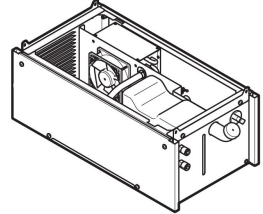
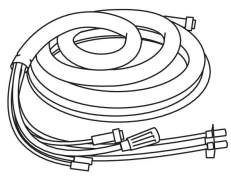
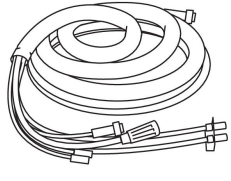
0465 424 880	Remote outlet kit	
0465 416 880	Wheel kit	
0465 510 880	Trolley	
0465 427 880	Cooling unit	
Connection set, 70 mm², 19 poles		
0459 836 880	2 m	
0459 836 881	5 m	
0459 836 882	10 m	
0459 836 883	15 m	
0459 836 884	25 m	
0459 836 885	35 m	
Connection set water, 70 mm², 19 poles		
0459 836 890	2 m	
0459 836 891	5 m	
0459 836 892	10 m	
0459 836 893	15 m	
0459 836 894	25 m	
0459 836 895	35 m	

Connection set, 95 mm², 19 poles		
0459 836 980	2 m	
0459 836 981	5 m	
0459 836 982	10 m	
0459 836 983	15 m	
0459 836 984	25 m	
0459 836 985	35 m	
Connection set water, 95 mm², 19 poles		
0459 836 990	2 m	
0459 836 991	5 m	
0459 836 992	10 m	
0459 836 993	15 m	
0459 836 994	25 m	
0459 836 995	35 m	
TIG torches		
0700 300 539	TXH™ 151 V, OKC 50, 4 m	
0700 300 545	TXH™ 151 V, OKC 50, 8 m	
0700 300 553	TXH™ 201 V, OKC 50, 4 m	
0700 300 556	TXH™ 201 V, OKC 50, 8 m	
Arc air torches		
0468 253 880	Flair 600 incl monocable 2.5 m	
0468 253 016	Torch only	
0468 253 015	Monocable only	
0468 253 881	Flair 1600 incl monocable 2.5 m	
0468 253 036	Torch only	
0468 253 035	Monocable only	

ESAB subsidiaries and representative offices

Europe

AUSTRIA

ESAB Ges.m.b.H
Vienna-Liesing
Tel: +43 1 888 25 11
Fax: +43 1 888 25 11 85

BELGIUM

S.A. ESAB N.V.
Brussels
Tel: +32 2 745 11 00
Fax: +32 2 745 11 28

BULGARIA

ESAB Kft Representative Office
Sofia
Tel: +359 2 974 42 88
Fax: +359 2 974 42 88

THE CZECH REPUBLIC

ESAB VAMBERK s.r.o.
Vamberk
Tel: +420 2 819 40 885
Fax: +420 2 819 40 120

DENMARK

Aktieselskabet ESAB
Herlev
Tel: +45 36 30 01 11
Fax: +45 36 30 40 03

FINLAND

ESAB Oy
Helsinki
Tel: +358 9 547 761
Fax: +358 9 547 77 71

GREAT BRITAIN

ESAB Group (UK) Ltd
Waltham Cross
Tel: +44 1992 76 85 15
Fax: +44 1992 71 58 03

ESAB Automation Ltd
Andover
Tel: +44 1264 33 22 33
Fax: +44 1264 33 20 74

FRANCE

ESAB France S.A.
Cergy Pontoise
Tel: +33 1 30 75 55 00
Fax: +33 1 30 75 55 24

GERMANY

ESAB GmbH
Solingen
Tel: +49 212 298 0
Fax: +49 212 298 218

HUNGARY

ESAB Kft
Budapest
Tel: +36 1 20 44 182
Fax: +36 1 20 44 186

ITALY

ESAB Saldatura S.p.A.
Bareggio (Mi)
Tel: +39 02 97 96 8.1
Fax: +39 02 97 96 87 01

THE NETHERLANDS

ESAB Nederland B.V.
Amersfoort
Tel: +31 33 422 35 55
Fax: +31 33 422 35 44

NORWAY

AS ESAB
Larvik
Tel: +47 33 12 10 00
Fax: +47 33 11 52 03

POLAND

ESAB Sp.zo.o.
Katowice
Tel: +48 32 351 11 00
Fax: +48 32 351 11 20

PORTUGAL

ESAB Lda
Lisbon
Tel: +351 8 310 960
Fax: +351 1 859 1277

ROMANIA

ESAB Romania Trading SRL
Bucharest
Tel: +40 316 900 600
Fax: +40 316 900 601

RUSSIA

LLC ESAB
Moscow
Tel: +7 (495) 663 20 08
Fax: +7 (495) 663 20 09

SLOVAKIA

ESAB Slovakia s.r.o.
Bratislava
Tel: +421 7 44 88 24 26
Fax: +421 7 44 88 87 41

SPAIN

ESAB Ibérica S.A.
Alcalá de Henares (MADRID)
Tel: +34 91 878 3600
Fax: +34 91 802 3461

SWEDEN

ESAB Sverige AB
Gothenburg
Tel: +46 31 50 95 00
Fax: +46 31 50 92 22

ESAB International AB
Gothenburg
Tel: +46 31 50 90 00
Fax: +46 31 50 93 60

SWITZERLAND

ESAB AG
Dietikon
Tel: +41 1 741 25 25
Fax: +41 1 740 30 55

UKRAINE

ESAB Ukraine LLC
Kiev
Tel: +38 (044) 501 23 24
Fax: +38 (044) 575 21 88

North and South America

ARGENTINA

CONARCO
Buenos Aires
Tel: +54 11 4 753 4039
Fax: +54 11 4 753 6313

BRAZIL

ESAB S.A.
Contagem-MG
Tel: +55 31 2191 4333
Fax: +55 31 2191 4440

CANADA

ESAB Group Canada Inc.
Mississauga, Ontario
Tel: +1 905 670 02 20
Fax: +1 905 670 48 79

MEXICO

ESAB Mexico S.A.
Monterrey
Tel: +52 8 350 5959
Fax: +52 8 350 7554

USA

ESAB Welding & Cutting
Products
Florence, SC
Tel: +1 843 669 44 11
Fax: +1 843 664 57 48

Asia/Pacific

AUSTRALIA

ESAB South Pacific
Archerfield BC QLD 4108
Tel: +61 1300 372 228
Fax: +61 7 3711 2328

CHINA

Shanghai ESAB A/P
Shanghai
Tel: +86 21 2326 3000
Fax: +86 21 6566 6622

INDIA

ESAB India Ltd
Calcutta
Tel: +91 33 478 45 17
Fax: +91 33 468 18 80

INDONESIA

P.T. ESABindo Pratama
Jakarta
Tel: +62 21 460 0188
Fax: +62 21 461 2929

JAPAN

ESAB Japan
Tokyo
Tel: +81 45 670 7073
Fax: +81 45 670 7001

MALAYSIA

ESAB (Malaysia) Snd Bhd
USJ
Tel: +603 8023 7835
Fax: +603 8023 0225

SINGAPORE

ESAB Asia/Pacific Pte Ltd
Singapore
Tel: +65 6861 43 22
Fax: +65 6861 31 95

SOUTH KOREA

ESAB SeAH Corporation
Kyungnam
Tel: +82 55 269 8170
Fax: +82 55 289 8864

UNITED ARAB EMIRATES

ESAB Middle East FZE
Dubai
Tel: +971 4 887 21 11
Fax: +971 4 887 22 63

Africa

EGYPT

ESAB Egypt
Dokki-Cairo
Tel: +20 2 390 96 69
Fax: +20 2 393 32 13

SOUTH AFRICA

ESAB Africa Welding & Cutting
Ltd
Durbanvill 7570 - Cape Town
Tel: +27 (0)21 975 8924

Distributors

For addresses and phone numbers to our distributors in other countries, please visit our home page

www.esab.com



www.esab.com

